

Open Rack Single Serisi Dikili Tip Rack Kabin Montaj Kılavuzu ve Talimatları

(Open Rack Single Series Free Standing Rack Cabinet Installation Guide and Instructions)

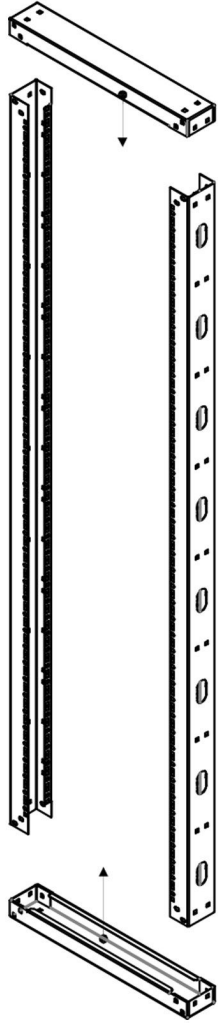

Alt ve üst en dikmeleri boy dikmelere uygun şekilde yerleştiriniz.
(Place the bottom and top vertical posts in alignment with the uprights.)

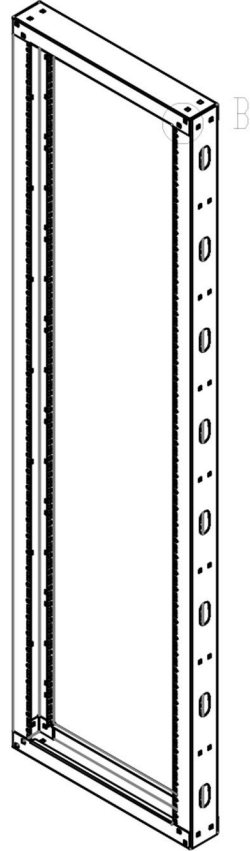

Deliklerin birbirini karşılması için parçalara baskı uygulayınız.
(Apply pressure to the parts to ensure that the holes align with each other.)

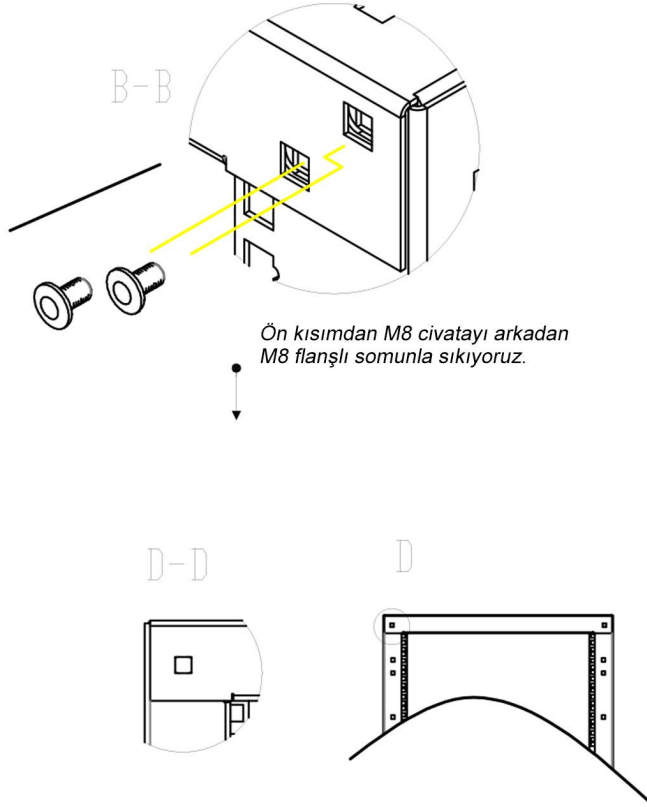

Ön kısımdan M8 civatayı arkadan M8 flanşlı somunla sıkıyoruz.

Boy dikmenin arka kısmında kalan tek delikli kısmı da M8 civata ve somun ile birbirine montajlayınız.
(Secure the single-hole portion at the rear of the upright with an M8 bolt and nut.)

Open Rack Single Serisi Dikili Tip Rack Kabin Montaj Kılavuzu ve Talimatları

(Open Rack Single Series Free Standing Rack Cabinet Installation Guide and Instructions)

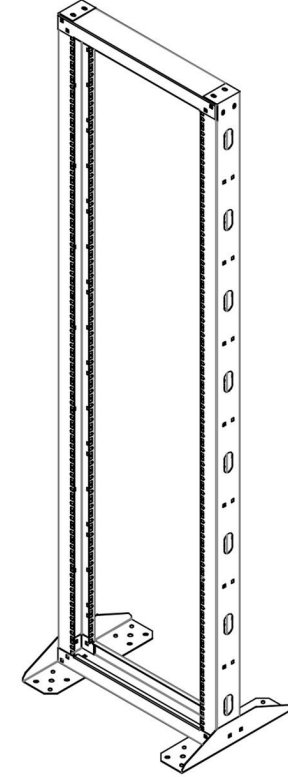
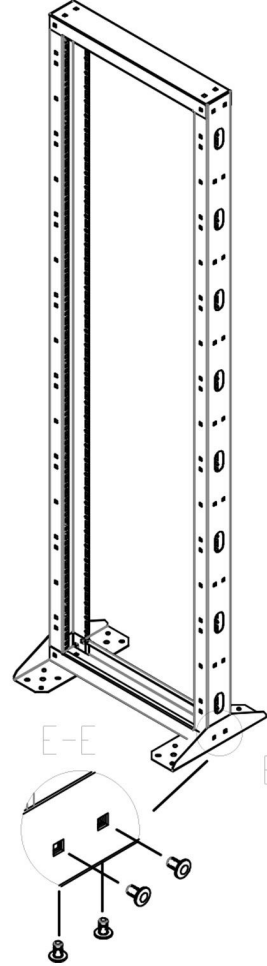
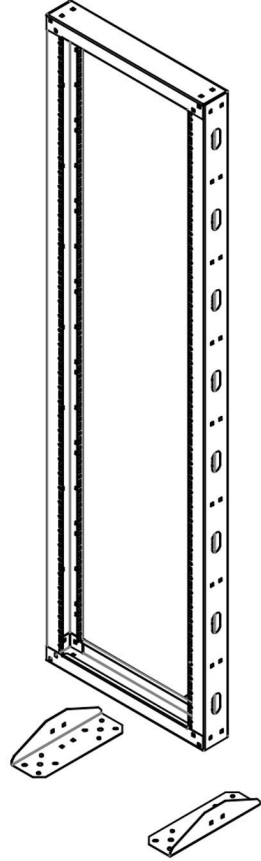



Ayak kısmını tercihinize göre, çerçeve yatay yada dikey şekildeyken montajlayabilirsiniz. Kolay montaj yapmak için çerçeveyi yatay şekile getiriniz.
(To facilitate easy assembly, you can mount the base in either a horizontal or vertical position according to your preference. We recommend positioning the frame horizontally.)





Ön ve alt kısımdan M8 civatayı M8 flanşlı somunlar iç kısımda kalacak şekilde sıkıyoruz.
(Tighten the M8 bolt from the front and bottom, ensuring that the M8 flanged nut remains on the inner side.)

Open Rack Single Serisi Dikili Tip Rack Kabin Dahili Donanım Malzemeleri

(Open Rack Series Free Standing Rack Cabinet Internal Hardware Materials)

28x M8x10 Mantar Başlı Kanal Civata (28x M8x10 M8 Allen Head Bolt)		28x M8 Altıköşe Flanşlı Somun (28x M8 Hexagon Flange Nut)							

Montaj için Gerekli Aletler (Tools Required For Assembly)

1x M8 Alyan Anahtarı (1x M8 Allen Key)		1x Pense (1x Pliers)		1x M8 Cırcır Kombine Anahtar (1x M8 Ratchet Combination Wrench)		1x Şarjlı Matkap (1x Cordless Drill)			
Amatör Seviye (Amateur Level)		Amatör Seviye (Amateur Level)		Amatör Seviye (Amateur Level)		Profesyonel Seviye (Professional Level)			